

CHAPTER 2 - WASTEWATER

"URBAN SERVICES STANDARDS AND GUIDELINES"

CITY OF PORT ANGELES - PUBLIC WORKS & UTILITIES DEPARTMENT

2.01 GENERAL CONSIDERATIONS

- A. Wastewater systems refer to sewage derived from domestic, commercial, and industrial waste to which storm water and groundwater are not intentionally admitted. Pretreatment of wastewater shall follow all the requirements as set forth by the City of Port Angeles Pretreatment Requirements in PAMC Chapter 13.06 and Washington State Department of Ecology Regulations.
- B. Any extension of the Port Angeles Wastewater System must be approved by the Department of Public Works and Utilities and all extensions must conform to Department of Ecology regulations and the Port Angeles Sewer Facility Plan. The material contained in these standards shall be used in conjunction with the Washington State Department of Ecology regulations to develop all plans and specification and construction of wastewater facilities. Where there are conflicts or differences between these standards and City ordinances, the City ordinances shall apply.
- C. It is the policy of the Public Works and Utilities Department that all parcels within the corporate City limits shall be encouraged to connect to the public sewer where a public sewer is available. A public sewer is determined to be available if the sewage from the premises originates within 200 feet of the public sewer, except where otherwise exempted by the joint written approval of the City Manager, the Clallam County Health Officer, and the Director of Public Works and Utilities. (PAMC 13.61.070) All septic tank permits are obtained from the Clallam County Health Department.
- D. City sewer service may be provided outside the limits of the City and inside its Urban Growth Area.
- E. Main extensions to be accepted by the City for maintenance and operation must be located in City or other public right of way.
- F. In designing and planning for any development, it is the developer's responsibility to see that adequate sewer systems are provided. The developer must show, in the proposed plans, how sewer facilities will be provided and whether the existing system will be adversely impacted. A detailed analysis of the system may be required.
- G. Anyone that wishes to extend or connect to the City's wastewater system should contact the Department of Public Works and Utilities for preliminary information and discussion of the extension proposed. The design of a wastewater system extension is the responsibility of the Developer/Owner proposing the construction and upgrading of the public wastewater system. Design of wastewater facilities shall be by a registered engineer in the State of Washington and will be reviewed by the City Engineer for compliance with these standards.
- H. Prior to acceptance by the City and the discharge of any wastewater, all improvements must be completed and approved including granting of right-of-way or easements, and all applicable fees must be paid.
- I. Issuance of building permits for new construction of single family residences within new subdivisions shall not occur until final Public Works approval of all improvements is given. For commercial projects, building permits may be issued upon completion and acceptance of the required fire protection facilities, providing the necessary easements and paying all required fees and connection charges. Certificates of occupancy will not be granted until final Public Works approval and acceptance of all improvements is given.

2.02 DESIGN STANDARDS

- A. The design of any wastewater extension/connection shall conform to these standards, the Washington State Department of Ecology "Criteria for Sewer Works Design" and any applicable standards as set forth in other chapters of these standards.
- B. The layout of extensions shall provide for the future continuation of the existing system as determined by the City Engineer. All sewers shall be designed as a gravity sewer whenever physically and/or economically feasible or as outlined in the Sewer Facility Plan. Main extensions shall be extended in accordance with Chapter 1.
- C. The following GENERAL CONDITIONS and those in Chapter 1, section 1A.085 shall be included on any

CHAPTER 2 - WASTEWATER

plans dealing with the wastewater system when a permit is required.

1. The City shall be given 72 hours notice prior to scheduling a diversion of flows in the wastewater system.
2. During the construction of mains and services, the contractor shall cap, plug, or secure the ends of such lines whenever the project is shut down at the end of the day so that contaminants will not enter the lines.
3. All lines shall be tested in conformance with the standard specifications. Prior to final acceptance of all installations, the City may conduct an inspection of all main lines by the use of television equipment. The City may request a television inspection to be completed by the Contractor, at the Contractor's expense.
4. The City construction inspector shall be notified a minimum of 48 hours in advance of the time that a tap connection to an existing main or a service connection to an existing main is needed so that the wastewater division crew may be scheduled for the work. The inspector shall be present at the time of the tap. All side sewer service connections to existing sewer mains and all taps to existing mains shall be made by City personnel at the expense of the contractor, unless the Contractor is specifically granted permission to perform the tap or service connection at the Contractor's expense.
5. All sewer mains shall be high velocity cleaned and pressure tested prior to paving the streets in conformance with the WSDOT/APWA Specifications, at the Contractor's expense. Hydrant flushing of lines is not an acceptable cleaning method. An air test of all lines is the minimum testing required. Testing of the main may include television inspection, if directed by the City. Testing shall take place after all underground utilities are installed and compaction of the roadway subgrade is completed.
6. Prior to backfilling, all sewer lines and appurtenances shall be inspected and approved by the City's inspector. Approval shall not relieve the contractor for correction of any deficiencies and/or failure as determined by subsequent testing and inspections. It shall be the contractor's responsibility to notify the City for the required inspections.

2.03 GRAVITY SEWER MAINS

- A. Sewer mains shall be sized for the ultimate development of the tributary area. New gravity sewer systems shall be designed on the basis of an average daily per capita flow of sewage of not less than 100 gallons per day. The table "Design Basis for Sewage Works" from the DOE Manual is assumed to cover normal infiltration, but additional allowance shall be made where conditions are unfavorable. Generally, laterals and submain sewers should be designed to carry, when running full, not less than 400 gallons daily per capita contributions of sewage. When deviations from the foregoing per capita rates are used, a description of the procedure used shall be submitted to the City Engineer for review and approval. Nothing shall preclude the City from requiring the installation of a larger sized main if the City determines that a larger size is needed to meet the requirements for future service. The Developer may be eligible for a Developer Reimbursement Agreement to recover additional costs.
- B. The minimum size for mains and submains shall be 8 inch inside diameter, except where 6" meeting DOE Manual requirements may be allowed.
- C. The minimum size for a service lateral within the City right-of-way shall be 6 inches in accordance with the City Standard Drawings. The depth at the property line shall be 5 foot minimum. Sewer connections to the main shall be made with a wye connection. All new mains connecting to existing mains shall require the installation of a new manhole if not made at an existing manhole.
- D. Sewer mains shall be PVC, ASTM D3034, SDR 35 or ASTM F789 with joints and rubber gaskets conforming to ASTM D3212 and ASTM F477 or ductile iron pipe conforming to ASTM A21.51 or AWWA C151 and shall be cement mortar lined, push-on joint, or mechanical joint, Class 50, or Concrete Sewer Pipe per WSDOT/APWA Specifications 9-05.7(1) and (2).
- E. All pipe and services shall be installed with continuous tracer tape.
- F. Gravity sewer mains typically have a depth of 5 feet. Actual depth will be determined by slope, flow, velocity, and elevation of existing system.

CHAPTER 2 - WASTEWATER

2.04 CONNECTIONS TO EXISTING SYSTEM

- A. All new sewer connections to the existing system shall be physically plugged until all tests have been completed and the City approves the removal of the plug.
- B. Connection of new sewer mains to existing manholes shall be accomplished by using provided knock-outs. Where knock-outs are not available, the manhole shall be core drilled or jack-hammered by the Contractor. The manhole base shall be rechanneled so as to provide smooth transitions into existing flows.
- C. Connection of a sewer main to a system where a manhole is not available shall be accomplished by pouring a concrete base and setting manhole sections. The existing pipe shall only be cut into by City crews, unless otherwise approved.
- D. Connections to manholes requiring a drop shall follow the criteria as outlined herein.
- E. Connections when a new building sewer is the same size as the existing main shall be accomplished by the installation of a new manhole on the City sewer main.
- F. Taps shall not be allowed to protrude into the existing main. All taps to existing mains and manholes shall be made by City crews, unless otherwise approved. If the contractor performs the taps, he shall notify the City inspector at least 48 hours prior to the tap. All taps shall be witnessed by the City inspector.
- G. The contractor is responsible for all shoring of trenches. If shoring is not adequate, the City crews will not enter the trench and the contractor will be responsible for the cost of an additional trip to the site by City crews.

2.05 MANHOLES

- A. Precast manholes shall meet the requirements of ASTM C478 with either a precast base or a cast-in-place base made from 3,000 psi structural concrete. Manholes shall be Type 1-48 (WSDOT Drawing B-23a) inch diameter minimum. Joints shall be rubber gasketed conforming to ASTM C443 and shall be grouted from the inside. Lift holes shall be grouted from the outside and inside of the manhole. Manholes constructed of other materials may be approved by the City Engineer, provided they meet the requirements of the Department of Ecology. Material specifications need to be submitted for review before an alternate material will be considered.
- B. Eccentric manhole cone shall be offset so as not to be located in the tire track of a traveled lane and shall be in line with the manhole steps.
- C. Manhole frames and covers shall be cast iron marked "Sewer" conforming to the requirements of ASTM A536, Grade 80-55-06, Olympic Foundry Type MH 30D/T, or approved equal. Repair of defects shall not be permitted. The minimum clear opening in the manhole frame shall be 24 inches. Manhole rings and covers shall be machine-finished or ground-on seating surfaces so as to assure non-rocking fit in any position and interchangeability. Manholes located in areas subject to inflow shall be equipped with a PRECO sewer guard watertight manhole insert or approved equal.
- D. Lock-type casting shall only be called for on pressurized systems or as required by the City Engineer. Where lock-type castings are called for, the casting device shall be such that the cover may be readily released from the ring and all movable parts shall be made of non-corrosive materials and otherwise arranged to avoid possible binding.
- E. All casting shall be coated with bituminous coating prior to delivery to the job site.
- F. Safety steps shall be fabricated of polypropylene conforming to ASTM D-4101, injection molded around a 1/2 inch ASTM A-615 grade steel reinforcing bar with anti-slip tread. Steps shall project uniformly from the inside wall of the manhole. Steps shall be installed to form a continuous vertical ladder with rungs equally spaced on 12 inch centers and installed per WSDOT/APWA Standard Plan B-24.
- G. Generally, gravity sewers shall be designed with straight alignment between manholes, however, curved alignment may be permitted when conditions warrant, upon special approval of the City Engineer.
- H. Manholes shall be provided at a maximum of 400 foot intervals for 8 inch to 15 inch sewers, 500 foot

CHAPTER 2 - WASTEWATER

intervals for 18 inch to 30 inch sewers, at intersections, and at all changes in direction, grade or pipe size.

- I. Cleanouts at the end of sewer mains greater than 150 feet will not be accepted as a substitute for a manhole.
- J. Minimum slope through the manhole shall be 1/10th of one foot from the invert in to the invert out. All manholes shall be channeled.
- K. All manholes shall be located so that they are accessible by maintenance vehicles and shall be no closer than 5 feet from any surface obstruction.
- L. Manhole diameter sizing shall be based upon the number of pipes entering and exiting the manhole, the ability to achieve transitions in the flow, adequate shelves, room for maintenance and television inspections, and maintain the strength of the manhole.

2.06 SLOPES

- A. All sewers shall be designed and constructed to give mean velocities, when flowing full, of not less than 2.0 feet per second based on Manning's Formula using a minimum "n" value of 0.013. The following minimum slopes apply:

SIZE (INCHES)	MIN. % SLOPE (FEET PER 100)	SIZE (INCHES)	MIN. % SLOPE (FEET PER 100)
6	1.00% - (0.0100 FT/FT)	18	0.12% - (0.0012 FT/FT)
8	0.40% - (0.0040 FT/FT)	21	0.10% - (0.0010 FT/FT)
10	0.28% - (0.0028 FT/FT)	24	0.08% - (0.0008 FT/FT)
12	0.22% - (0.0022 FT/FT)	30	0.06% - (0.0006 FT/FT)
15	0.15% - (0.0015 FT/FT)	36	0.05% - (0.0005 FT/FT)

- B. Under special conditions, slopes slightly less than those required for the 2.0 feet per second velocity may be permitted by the City Engineer. Such decreased slopes will only be considered where the depth of flow will be 0.3 of the diameter or greater for design average flow. Whenever such decreased slopes are proposed, the design engineer shall furnish with the plans his computations of the depths of flow in such pipes at minimum, average, and daily or hourly rates of flow. Larger pipe size shall not be allowed to achieve lesser slopes.
- C. Sewers shall be laid with uniform slope between manholes.
- D. Where sewer mains are laid on slopes of 6.0 percent or greater or where ground water may use the trench as a conduit, check dams may be required to be placed along the pipe. The spacing shall be noted on the plans.
- E. Sewer mains on 20 percent slope or greater shall be anchored securely with concrete anchors, or other approved method. The concrete anchors shall conform to the WSDOT/APWA Standard Plan No. B-12 and the spacing shall be as follows:
 1. 20% to 35%, not over 36 feet center to center spacing
 2. 35% to 50%, not over 24 feet center to center spacing
 3. 50% and over, not over 16 feet center to center spacing

2.07 INCREASING SIZE

- A. Manholes shall be provided where pipe size changes occur.
- B. Where a smaller sewer main joins a larger one, the invert of the larger sewer should be lowered sufficiently to maintain the same energy gradient. An approximate method for securing these results is to place the 0.8 depth point of both sewers at the same location at the intersection of pipe centerlines in the manhole.

CHAPTER 2 - WASTEWATER

2.08 HIGH VELOCITY PROTECTION

Where velocities greater than 15 feet per second are expected, special provisions such as thrust blocking and piping materials shall be made to protect against displacement by erosion and shock.

2.09 DROPS

- A. Straight grades between invert out of last manhole and connection to existing manhole are preferred over drops. Care must be taken when designing steep grades or sweeps so as not to create a situation of excessive velocity or excavation. Grade changes associated with sweeps shall not be allowed, unless otherwise approved by the City Engineer.
- B. An outside drop connection shall be provided for a sewer entering a manhole at an elevation of 24 inches or more above the manhole invert. Where the difference in elevation between the incoming sewer and the manhole invert is less than 24 inches, the invert shall be filleted to prevent solids deposition in the manhole.
- C. An inside drop connection will not be allowed by the City, unless otherwise approved by the City Engineer.
- D. Outside drop connections shall be constructed per City Standard Drawing. Where the slope of the sewer main connecting to a drop connection exceeds 8.0 percent, a bend fitting shall be installed on the drop connection which most closely matches the angle made from the horizontal plane by the pipe.

2.10 BUILDING SEWER

A building sewer or side sewer refers to the extension from the building plumbing at a point two feet from the outside of the outer foundation wall of the structure to the public sewer. The minimum size pipe for side sewers in the public right-of-way is 6-inch inside diameter.

- A. The minimum size pipe for building sewers shall be 4-inch inside diameter; except that all building sewers serving commercial/industrial buildings shall be a minimum pipe size of 6-inch inside diameter.
- B. A maximum of one single family residential unit may be connected with a 4-inch diameter building sewer.
- C. The minimum size of a dual residential, commercial/industrial and multi-family building sewer is 6-inch.
- D. Minimum slope on side sewers and building sewers shall be 2.0 percent. All side sewers must gravity into the City's sewer system, unless otherwise approved. The maximum slope for a side sewer is 100 percent and special plans may be required for such installations.
- E. Each side sewer will terminate at the property line or easement line (whichever is further) with a plug for each lot/ building/dwelling to be served. If a cleanout is installed, it shall be brought to within six (6) inches of finish grade, plugged with a threaded plug, and enclosed in a high-density polyethylene valve box with cover.
- F. The building sewer shall be connected to the side sewer and extend to the building to be served.
- G. A side sewer serving a commercial/industrial building or facility which has the potential of discharging grease, oil, and/or chemicals to the sanitary sewer will be required to connect to the main sewer line at a manhole (i.e., restaurants, service stations/garages, photo labs, processing facilities, etc.), or construct an accessible manhole on their property prior to the connection to the main sewer.
- H. Side sewer construction shall conform to the latest edition of the Uniform Plumbing Code and Chapter 13 of the Port Angeles Municipal Code.
- I. A separate and independent side sewer shall be constructed for every building, except where multiple building connections are approved by the Director of Public Works and Utilities.(PAMC 13.62.010).
- J. Maintenance of the building or side sewer is the sole responsibility of the property owner.(PAMC 13.62.020).
- K. Prior to connection of the building sewer to the public sewer a connection permit must be obtained from the Public Works and Utilities Department. During the permit process, the City may request additional information about the type and amount of flows anticipated in the side sewer.

2.11 DESIGN STANDARDS - LIFT STATIONS

CHAPTER 2 - WASTEWATER

The design of any lift station shall conform to City ordinances, Department of Ecology's "Criteria of Sewage Works Design" and applicable standards as set forth in these standards. Pump stations and force mains are special designs and require a pre-design meeting with the City Engineer prior to starting design. The following is a brief summary of minimum lift station requirements:

- A. An overall site drawing of the lift station showing the location of all components including elevations;
- B. Service size, voltage and enclosure type and location in relation to the pump station;
- C. A list of specific materials used including quantity description and manufacturer names;
- D. A schematic and line diagram of the service and motor control center and lift station;
- E. The electrical system shall be designed to meet all applicable state and local electrical codes;
- F. The plans shall show all applicable telemetry installation with schematics;
- G. An operation and maintenance manual from the lift station manufacturer shall be supplied;
- H. A lift station emergency pump out connection and emergency generator power connection shall be installed.
- I. A design report shall be submitted with each lift station demonstrating its conformance with the standards and shall address the following items:
 - 1. PUMP DATA - Size and type, Horsepower, Pump curves, Head capacity, Velocity
 - 2. MOTOR - Size and type, Cycle length, Type of mount
 - 3. CONTROLS - Type
 - 4. TELEMETRY - Alarm System Compatible with City system
 - 5. WELL SIZING - Type, Storage capacity
 - 6. TESTING - Operational systems, Pressure
 - 7. PIPING and VALVES - Size and type, bypass
 - 8. AUX. POWER - Connection for generator, Auxiliary generator, as directed
 - 9. SITE LAYOUT - Location on property
 - 10. ELECTRICAL SERVICE - Size and type, Source
 - 11. HOUSING -Size and type, Ventilation, Humidity control, Internal lighting, Access
 - 12. CORROSION PROTECTION - Type of materials, Coatings, Linings, Maintenance
 - 13. MAINTENANCE - Warranty, Tools & equipment required
- J. The design capacity of a pump station will be computed on the basis of the total area and projected population that can be served by the pump station.
- K. Pump stations may be either dry well/wet well type or submersible type.
- L. Where 100 or more single-family dwellings or equivalent living units are to be connected to a pump station, an automatic transfer switch (ATS) and standby diesel generator shall be installed. The ATS and generator shall be housed in a City-approved structure.
- M. Where fewer than 100 single-family dwellings or equivalent living units are to be connected to a pump station, a power transfer switch with emergency generator receptacle compatible with City portable generators shall be provided.
- N. Where on-site generators are not provided, standby storage tanks shall be provided and sized to handle a 6-hour peak flow. Storage tanks shall be provided with a means of draining back into the wet well.
- O. Electrical control equipment shall be housed above ground level in the structure provided for the standby generator, when required, or in a City-approved enclosure. Electrical controls will not be allowed in a dry well.

CHAPTER 2 - WASTEWATER

- P. A 6-foot high chain-link fence shall be installed around the pump station perimeter, with a 16-foot wide double swing gate.
- Q. A telemetry system shall be installed at the pump station which shall be connected to and compatible with the existing City alarm system for transferring alarm conditions from the pump station to the central alarm monitor.
- R. Each pump station design shall include a launch station for a pipeline cleaning device commonly referred to as a pig.

2.12 DESIGN STANDARDS - PRESSURE SEWERS (FORCE MAINS)

The design of any force main shall conform to City ordinances, Department of Ecology's "Criteria of Sewage Works Design" and applicable standards as set forth in these standards. Pump stations and force mains are special designs and require a pre-design meeting with the City Engineer prior to starting design. The following is a brief summary of minimum force main requirements:

- A. The design flows for force mains shall be that of the lift station maximum pumping capacity.
- B. Force main minimum size shall be 4 inch diameter.
- C. Force mains for sizes 4 inches to 24 inches shall be (1) ductile iron AWWA C151, Class 50, (2) PVC AWWA C900 pressure class pipe, or (3) high density polyethylene (HDPE) with a minimum thickness of SDR 21. A more rigid pipe may be required where limited trench widths may occur. All ductile iron pipe and fittings shall be epoxy coated or PE lined and designed for use with corrosive materials.
- D. Force mains shall have a minimum 36 inches of cover to the top of the pipe.
- E. The minimum velocity allowed is 2 feet per second at average Wet Weather Flows. 2 feet per second is required to maintain solids in suspension although 3 feet per second is desired to scour settled solids. The maximum velocity allowed shall be 8 feet per second.
- F. All pressure sewers shall be installed with continuous tracer tape.
- G. Air release valves and air/vacuum valves shall be located at the high points of the line within a standard 48 inch manhole or a comparable sized, approved vault. Air release valves shall be fitted with an activated carbon canister to absorb compounds with disagreeable odors prior to releasing the air to the surrounding area. Grades shall be designed to minimize the need for air/vacuum valves when practical. Vehicular access to valves is required for maintenance.
- H. Provisions to drain a force main to facilitate repairs or to temporarily remove the force main from service shall be provided. This may be accomplished through the use of a valved tee connected to a drain line at the low point of the line. A manhole shall be set over the force main at the valved tee.
- I. Location of thrust blocking shall be shown on the plans. Thrust block concrete shall be poured against undisturbed earth. A plastic barrier shall be placed between the thrust block and the fittings. See City Standard Drawing.
- J. Hydrogen sulfide odors and the buildup of sulfuric acid occur in the operation of a force main. To mitigate these conditions some type of control method(s) shall be used. This may include chemical addition at the pump station and/or the reaeration of the waste water at or near the terminus. Reaeration and protection may include the following:
 - 1. Construction of a vault housing an aspiration assembly.
 - 2. The use of hydraulic fall (vertical siphon) within the terminal manhole.
 - 3. High velocity discharge with smooth transition so as to not cause splashing of force main fluids into the down stream gravity sewer.
 - 4. At a minimum the manhole at the terminus and the first manhole downstream of the terminus shall be coated with Tnemec 120 vinyl ester, quantum polymorphic resin or approved equal which is resistant to sulfuric acid and hydrogen sulfide. ADS manhole may be considered as an alternative.

2.13 SANITARY SEWER/WATER MAIN CROSSINGS

CHAPTER 2 - WASTEWATER

- A. The contractor shall maintain a minimum of 18 inches of vertical separation between sanitary sewers and water mains. The minimum cover for water main of 36 inches may be reduced to 18 inches upon approval of the City Engineer to provide for as much vertical separation as possible.
- B. The longest standard length of water pipe shall be installed so that the joints will fall equidistant from any sewer crossing. In some cases where minimum separation cannot be maintained, it may be necessary to encase the water pipe and/or sewer service in a pipe or concrete. No concrete shall be installed unless specifically directed and inspected by the City Engineer.

2.14 TRENCH EXCAVATION, BEDDING AND BACKFILL

All work in this section shall be accomplished in accordance with Section 7-08 of the most recent Standard Specifications for Road, Bridge and Municipal Construction, published by the Washington State Department of Transportation, and as contained herein.

- A. Clearing and grubbing where required shall be performed within the easement or public right-of-way as permitted by the City and/or governing agency. Debris resulting from the clearing and grubbing shall be disposed of by the owner or contractor in accordance with the terms of all applicable permits. If trenching or backfilling will be performed in areas where infiltration facilities are planned, deviation from the WSDOT Standard Specifications for compaction requirements will be allowed.
- B. The trench shall be kept free from water until jointing is complete. Surface water shall be diverted so as not to enter the trench. The owner shall maintain sufficient pumping equipment on the job to insure that these provisions are carried out.
- C. Trenching and shoring operations shall not proceed more than 100 feet in advance of pipe laying without approval of the City Engineer.
- D. Backfilling with native materials excavated from the trenches may only occur with the written approval of the City Engineer.
- E. In paved areas within the public right of way the contractor shall use controlled density backfill per City Standard Drawing. Alternative materials may only be accepted with the written approved by the City Engineer.

2.15 STREET PATCHING AND RESTORATION

See Chapter 3 section 3B.170 and 3B.180 regarding patching and trench restoration.

2.16 TESTING

Prior to acceptance and approval of construction, the following tests shall apply to each type of construction.

A. Gravity Sewer

1. Prior to acceptance of the project, the gravity sewer pipe shall be subject to a low pressure air test per WSDOT/APWA Standards - 7-17.3(4)D. The contractor shall furnish all equipment and personnel for conducting the test under the observation of the City inspector. The testing equipment shall be subject to approval .

The contractor shall make an air test for his own purposes prior to notifying the City to witness the test. The acceptance air test shall be made after trench is backfilled and compacted and the roadway section is completed to subgrade.

All wyes, tees, and end of side sewer stubs shall be plugged with flexible joint caps, or acceptable alternatives and securely fastened to withstand the internal test pressures. Such plugs or caps shall be readily removable and their removal shall provide a socket suitable for making flexible jointed lateral connection or extension.

2. If the City is uncertain about taps, connections, construction material and/or methods, or other constructions items, it may order that testing of the sewer main shall include a television inspection by the contractor or the City at the expense of the contractor. Television inspection shall be done after the air test has passed and before the roadway is paved. Immediately prior to a television inspection, enough water shall be run down the line so it comes out the lower manhole. A copy of the video tape

CHAPTER 2 - WASTEWATER

and written report shall be submitted to the City. Acceptance of the line will be made after the tape has been reviewed and approved by the inspector. Any tap to the existing system may also be requested to be television inspected.

3. A water test of all manholes is also required. The water test shall be made by the contractor first by filling the manhole up with water and letting it sit for 24 hours to allow the water to saturate the concrete. After 24 hours the manhole shall be filled to the top of the cone. The water cannot drop more than 0.05 gallons in 15 minutes per foot of head above the invert of the manhole to pass the test. Upon completion of the water test the water shall be pumped out of the manhole and not allowed to be released into the system.
4. A mandrel test in accordance with WSDOT/APWA Specifications-7-17.3(4)H may be required by the City Engineer on sewers except laterals where deflection of the pipeline is suspected.

B. Force Main

1. Prior to acceptance of the project, the pressure line and service lines shall be subjected to a hydrostatic pressure test of 200 pounds for 4 hours and any leaks or imperfections developing under the test shall be remedied by the contractor. No air will be allowed in the line. The main shall be tested between valves. Avoid hydrostatic pressure being placed against the opposite side of the valve being tested. The pressure test shall be maintained while the entire installation is inspected.

The contractor shall provide all necessary equipment and shall perform all work connected with the tests. Tests shall be made after all connections have been made. This is to include any and all connections as shown on the plan. The contractor shall perform all tests to assure that the equipment to be used for the test is adequate and in good operating condition and the air in the line has been released before requesting the City to witness the test.

2. A water test for all wet wells in accordance with the manhole water test for gravity sewer is required.
3. Pump operation, alarms, and electrical inspection of all lift stations is required.

-END OF CHAPTER 2

CHAPTER 2 - WASTEWATER

APPENDICES

CITY STANDARD DRAWINGS

	<u>Filename</u>
1. Single Sewer Service	singleservice.dwg
2. Dual Sewer Service	dualservice.dwg
3. Sewer Clean-Out Detail	cleanout.dwg
4. Outside Drop Manhole	outsidedropmh.dwg
5. Inside Drop Manhole	insidedropmh.dwg
6. Trench Detail	trench.dwg
7. Control Density Backfill (CDF)	<i>(See Chapter 5)</i>
8. Trash Enclosure	TrashEnclosure.dwg

B. WSDOT STANDARD PLANS (<http://www.wsdot.wa.gov/Design/standards/Plans.htm>)

1. Manhole and Manhole Details	Section B
--------------------------------	-----------



STANDARD DETAIL

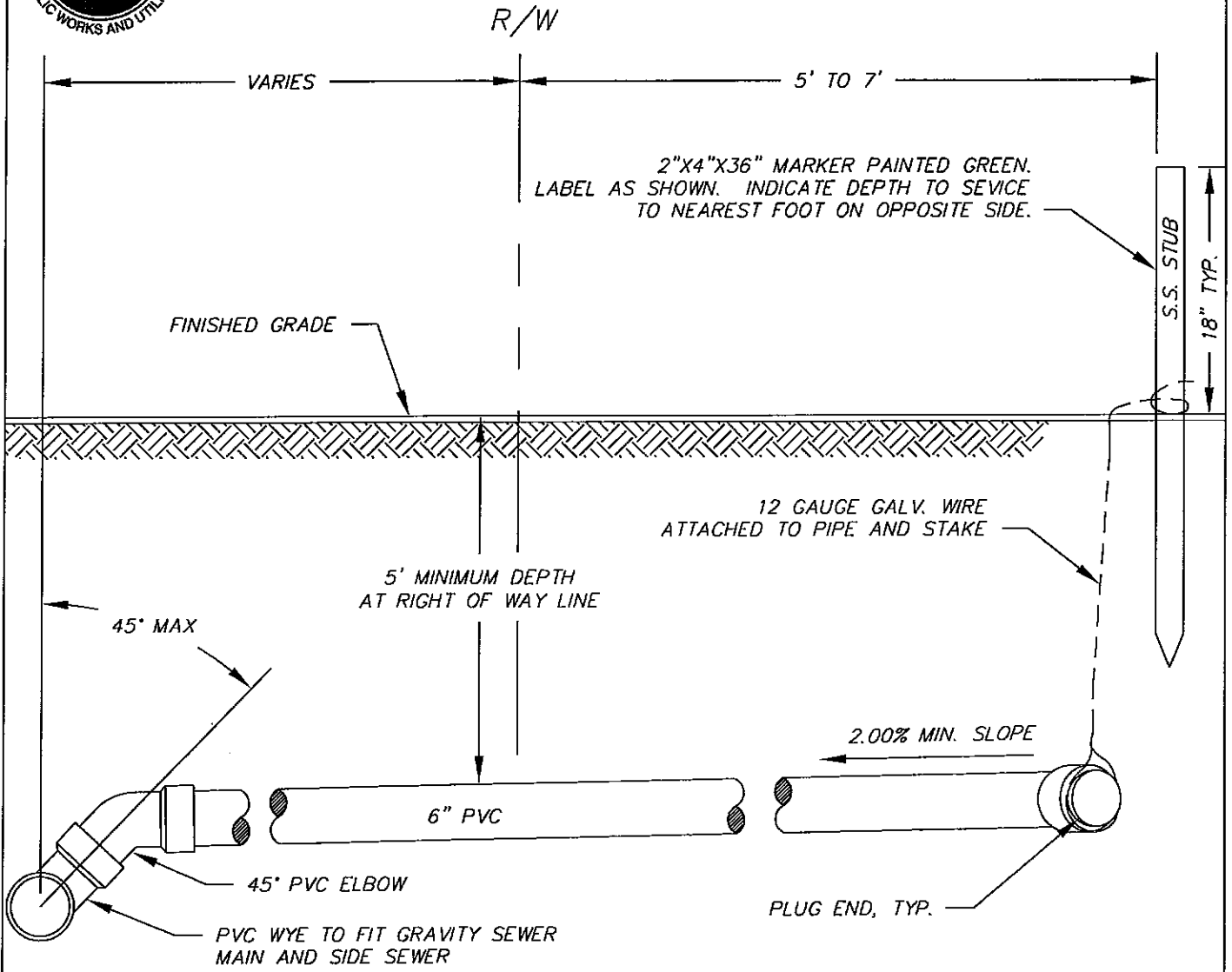

NOTES:

1. ROTATE THE 45° ELBOW TO ACHIEVE THE PROPER ANGLE TO REACH THE PROPERTY LINE WITH 5' OF COVER. MINIMUM ALLOWABLE SLOPE IS 2%.
2. 3' MINIMUM SEPARATION BETWEEN SIDE SEWER AND ADJOINING LOT LINE.
3. SEWER PIPE AND FITTINGS SHALL CONFORM TO THE REQUIREMENTS OF ASTM D 3034 SDR 35.
4. CALL FOR INSPECTION BY CITY 24 HOURS PRIOR TO PLACING BACKFILL

ALL WORK AND MATERIAL TO BE IN ACCORDANCE WITH THE CURRENT WASHINGTON STATE DEPARTMENT OF TRANSPORTATION "STANDARD SPECIFICATIONS FOR ROAD, BRIDGE, AND MUNICIPAL CONSTRUCTION"

APPROVED BY
CITY ENGINEER *[Signature]*
DATE : 5/10/05
REVISED : 3/15/06
FILE NAME: SINGLESERVICE.DWG

SINGLE SEWER SERVICE



STANDARD DETAIL

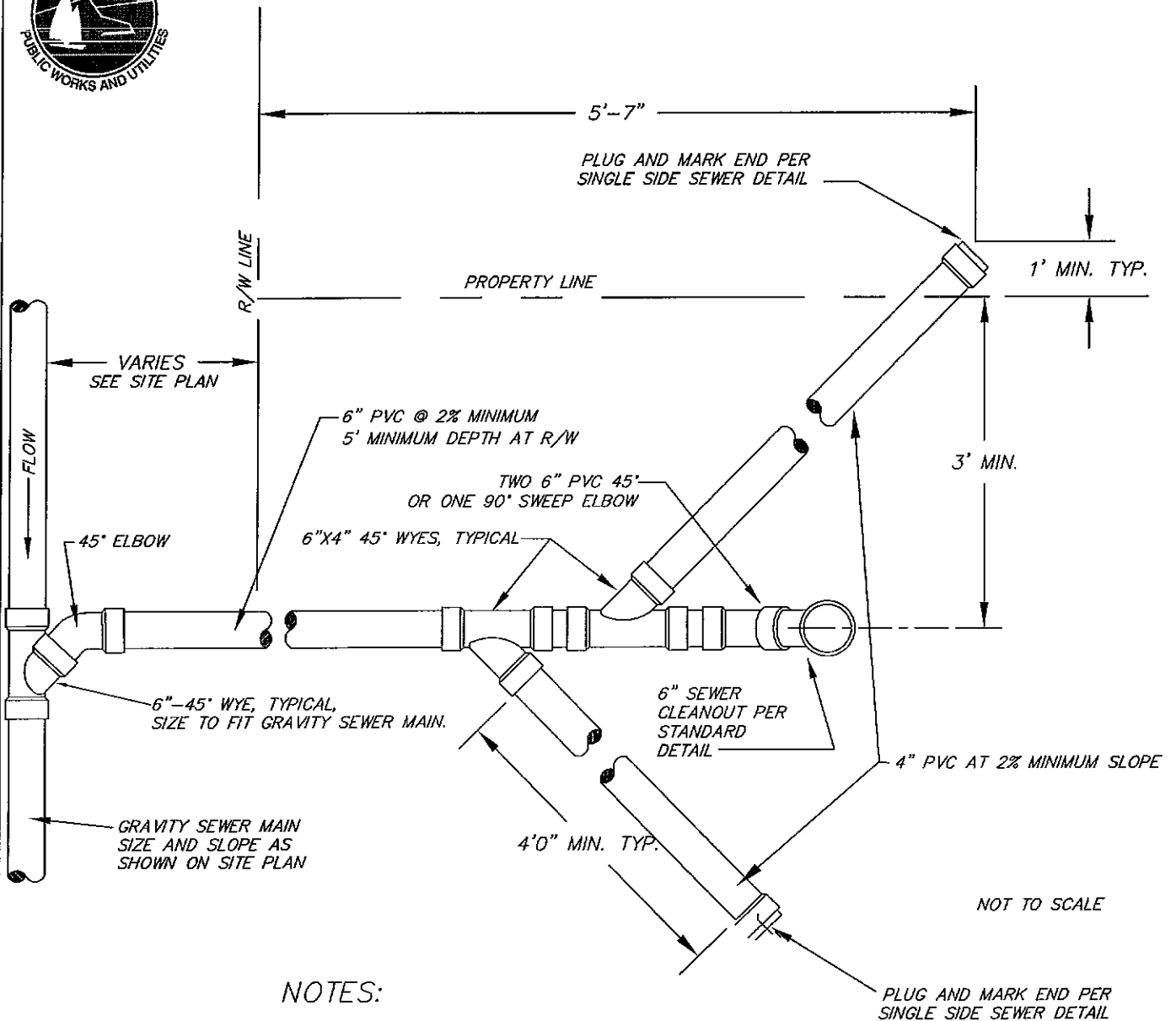

NOTES:

1. ROTATE THE 45° ELBOW TO ACHIEVE THE PROPER ANGLE TO REACH THE PROPERTY LINE WITH 5' OF COVER. MINIMUM ALLOWABLE SLOPE IS 2%.
2. 3' MINIMUM SEPARATION BETWEEN SIDE SEWER AND ADJOINING LOT LINE.
3. SEWER PIPE AND FITTINGS SHALL CONFORM TO THE REQUIREMENTS OF ASTM D 3034 SDR 35.
4. CALL FOR INSPECTION BY CITY 24 HOURS PRIOR TO PLACING BACKFILL

ALL WORK AND MATERIAL TO BE IN ACCORDANCE WITH THE CURRENT WASHINGTON STATE DEPARTMENT OF TRANSPORTATION "STANDARD SPECIFICATIONS FOR ROAD, BRIDGE, AND MUNICIPAL CONSTRUCTION"

APPROVED BY
CITY ENGINEER: *[Signature]*
FILE NAME: DUALSEWER.DWG

DATE: 5/10/05
REVISED: 3/15/06

DUAL SEWER SERVICE



STANDARD DETAIL

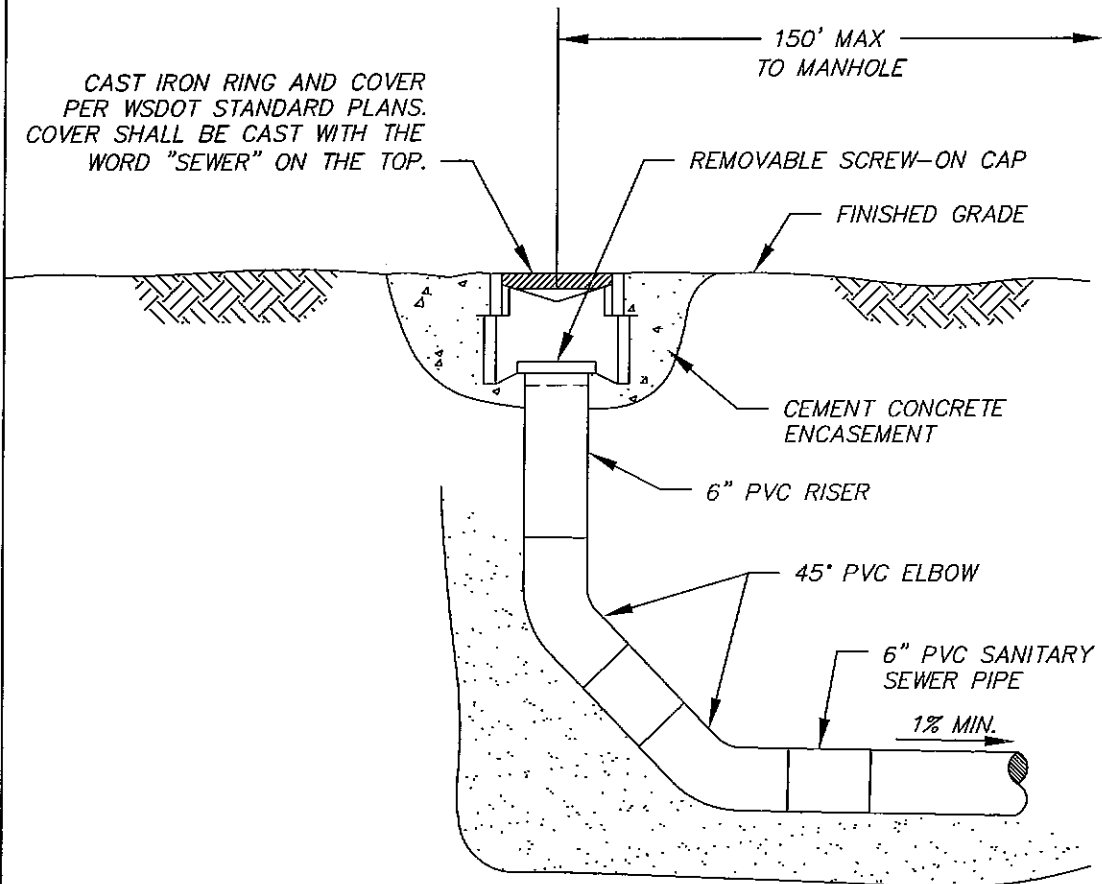

NOTES:

1. SEWER PIPE AND FITTINGS SHALL CONFORM TO THE REQUIREMENTS OF ASTM D 3034 SDR 35.
2. CALL FOR FORM/PIPE INSPECTION BY CITY 24 HOURS PRIOR TO POURING CONCRETE OR CDF BACKFILL

ALL WORK AND MATERIAL TO BE IN ACCORDANCE WITH THE CURRENT WASHINGTON STATE DEPARTMENT OF TRANSPORTATION "STANDARD SPECIFICATIONS FOR ROAD, BRIDGE, AND MUNICIPAL CONSTRUCTION"

APPROVED BY CITY ENGINEER <i>[Signature]</i>	DATE : 5/10/05 REVISED : 3/15/06	<h2>SEWER CLEANOUT DETAIL</h2>
FILE NAME: CLEANOUT.DWG		



STANDARD DETAIL

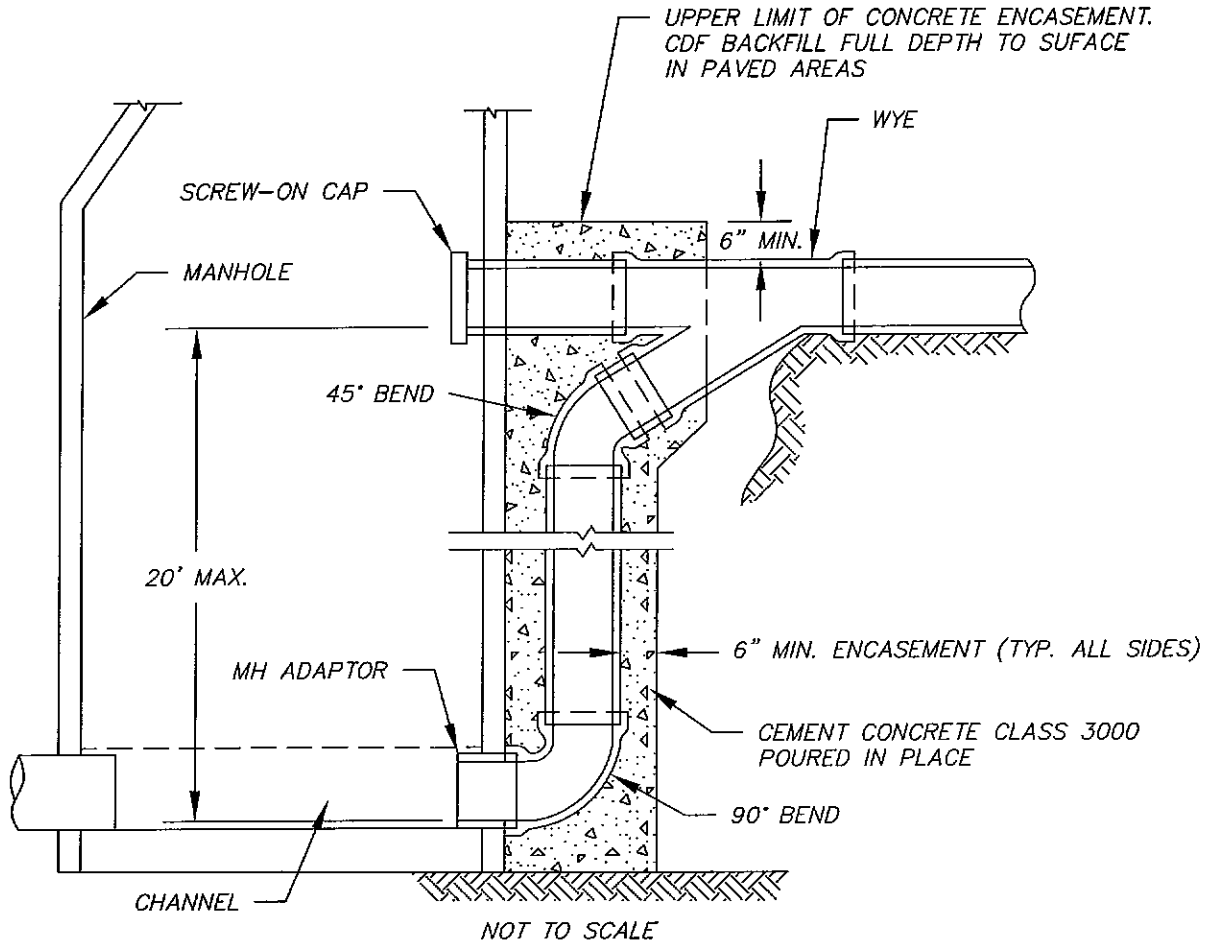

NOTES:

1. SEWER PIPE AND FITTINGS SHALL CONFORM TO THE REQUIREMENTS OF ASTM D 3034 SDR 35.
2. CALL FOR FORM/PIPE INSPECTION BY CITY 24 HOURS PRIOR TO POURING CONCRETE OR CDF BACKFILL

ALL WORK AND MATERIAL TO BE IN ACCORDANCE WITH THE CURRENT WASHINGTON STATE DEPARTMENT OF TRANSPORTATION "STANDARD SPECIFICATIONS FOR ROAD, BRIDGE, AND MUNICIPAL CONSTRUCTION"

APPROVED BY
CITY ENGINEER

DATE : 5/11/05

REVISED : 3/15/06

FILE NAME: OUTSIDEDROPMH.DWG

OUTSIDE DROP
MANHOLE CONNECTION



STANDARD DETAIL

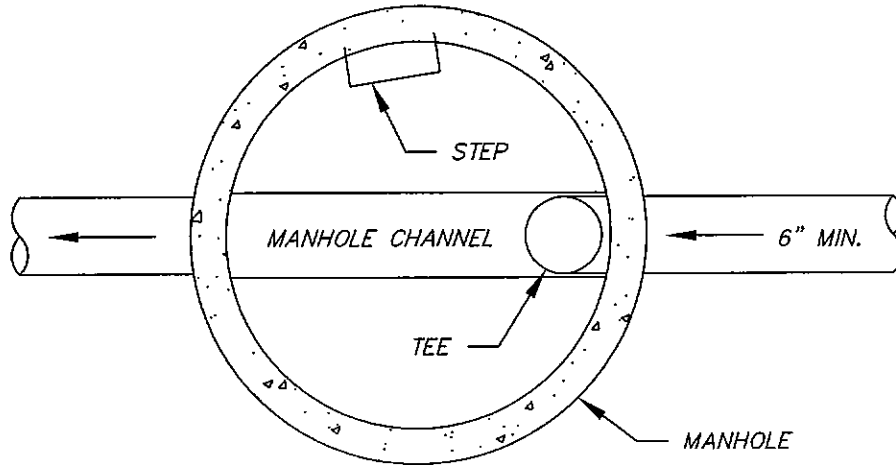

ALL WORK AND MATERIAL TO BE IN ACCORDANCE WITH THE CURRENT WASHINGTON STATE DEPARTMENT OF TRANSPORTATION "STANDARD SPECIFICATIONS FOR ROAD, BRIDGE, AND MUNICIPAL CONSTRUCTION"

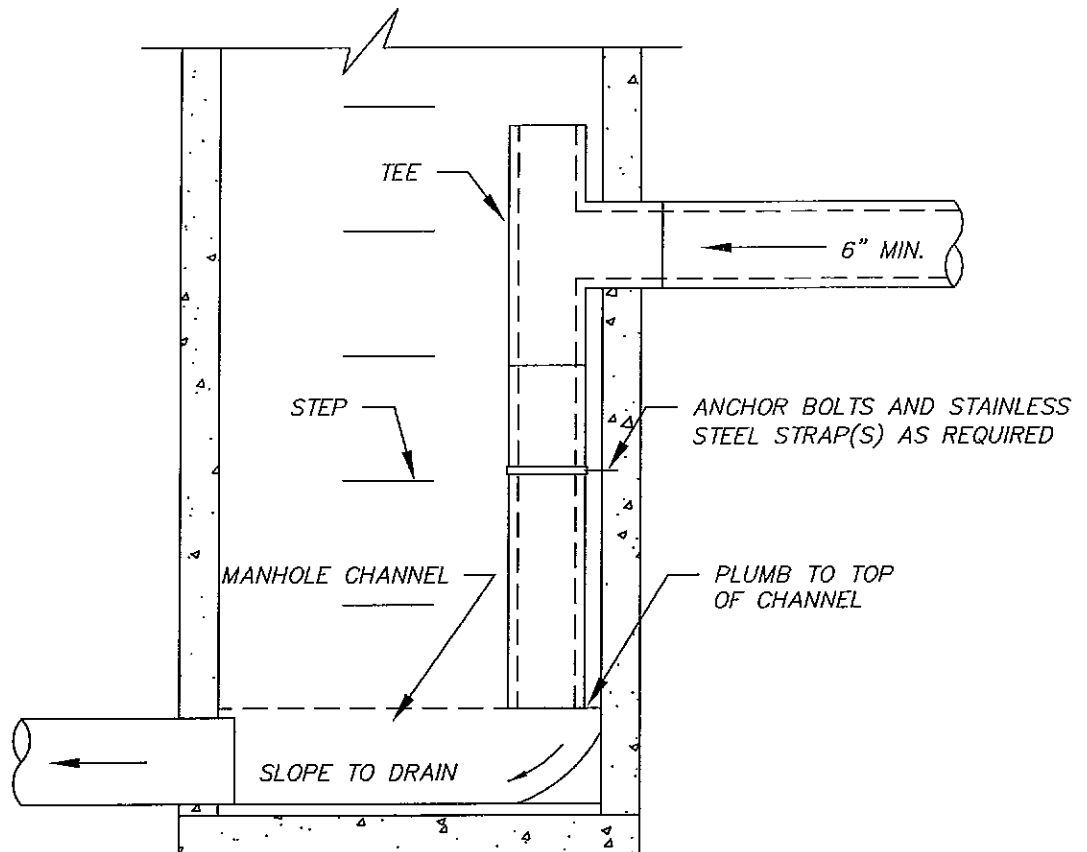

NOTES:

1. FOR LOW FLOW CONDITIONS ONLY. INSTALLATION REQUIRES PRIOR WRITTEN APPROVAL OF CITY ENGINEER.
2. CALL FOR INSPECTION UPON COMPLETION OF EXCAVATION FOR STRUCTURE INSTALLATION.
3. CALL FOR FORM/PIPE INSPECTION BY CITY 24 HOURS PRIOR TO POURING CONCRETE AND 24 HOURS PRIOR TO PAVING.

APPROVED BY
CITY ENGINEER 
FILE NAME: *INSIDEDROP.MH.DWG*

DATE : *5/18/05*
REVISED : *3/15/06*

INSIDE DROP MANHOLE



STANDARD DETAIL

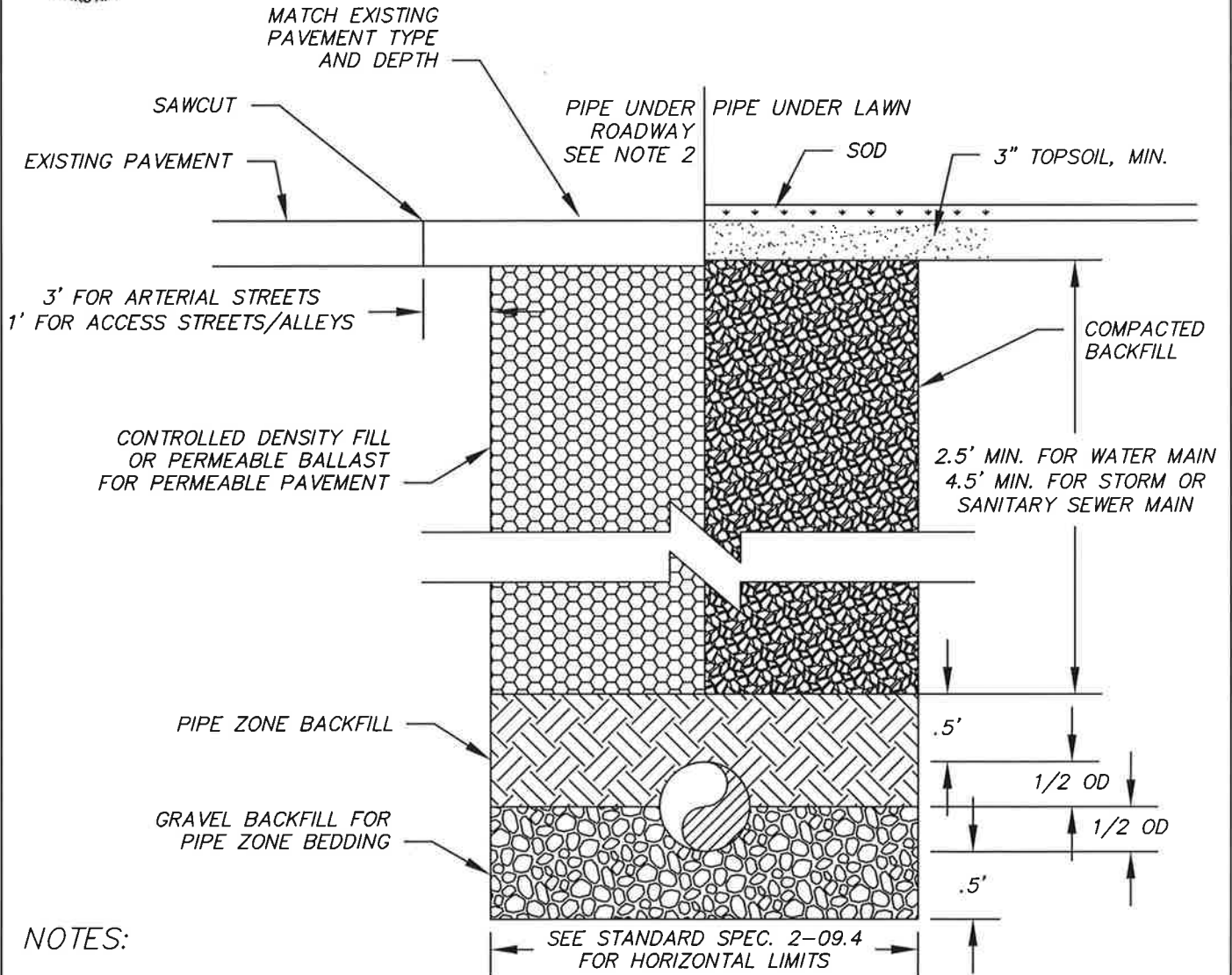

NOTES:

1. ACP PATCH SHALL BE ROLLED AND NOT VIBRATED.
2. TO BE USED FOR ALL PAVED STREETS AND ALLEYS. BACKFILL LOCATION TO 1'-0" BEHIND CURB OR EDGE OF PAVING UNLESS OTHERWISE APPROVED IN ADVANCE BY CITY ENGINEER.
3. WHERE CONCRETE PAVEMENT JOINT IS LESS THAN 4'-0" FROM SAWCUT, THE PAVEMENT SHALL BE REMOVED TO THAT JOINT.
4. TEMPORARY PATCHING WITH ASPHALT OR PLACEMENT OF STEEL PLATES IS REQUIRED WHEN TRAFFIC WILL CROSS CDF FOR MORE THAN 24 HOURS WITHOUT PERMANENT RESTORATION. STEEL PLATES SHALL HAVE COLD PATCH WEDGES ON TRAFFIC EDGES.
5. CALL FOR INSPECTION BY CITY 24 HOURS PRIOR TO PLACING PIPE ZONE BACKFILL AND PRIOR TO PLACING CDF BACKFILL.
6. IN AREAS WITHIN LID FACILITIES, COMPACTION BELOW 95% MAY BE APPROVED BY THE CITY.

ALL WORK AND MATERIAL TO BE IN ACCORDANCE WITH THE CURRENT WASHINGTON STATE DEPARTMENT OF TRANSPORTATION "STANDARD SPECIFICATIONS FOR ROAD, BRIDGE, AND MUNICIPAL CONSTRUCTION"

APPROVED BY
CITY ENGINEER :

DATE : 3/15/06
REVISED : 1/1/17

UTILITY TRENCH DETAIL

FILE NAME: TRENCH.DWG



STANDARD DETAIL

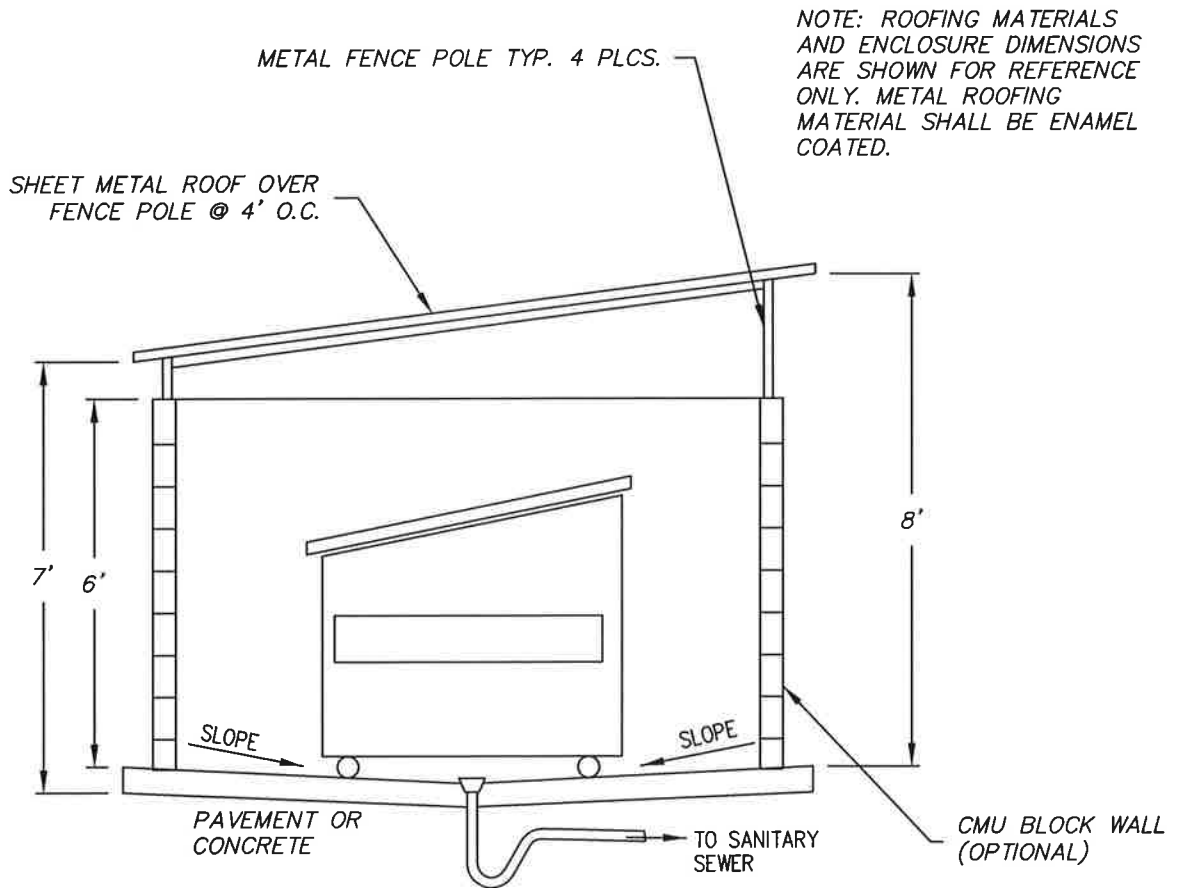

NOTE: ROOFING MATERIALS AND ENCLOSURE DIMENSIONS ARE SHOWN FOR REFERENCE ONLY. METAL ROOFING MATERIAL SHALL BE ENAMEL COATED.

NOTE: ADJACENT SURFACE SHALL BE SLOPED AWAY FROM ENCLOSURE TO PREVENT STORMWATER DISCHARGE TO SANITARY SEWER

APPROVED BY
CITY ENGINEER :

DATE : 1/1/17
REVISED :

TRASH ENCLOSURE

FILE NAME: TRASH ENCLOSURE

